

# SASA SERIES FIRE & SMOKE DAMPER ACTUATOR

3 Point Non Spring Return Control  
10 Nm

# NENUTEC<sup>®</sup>

INNOVATIVE MEMBER OF SWISSTECH

**NENUTEC ASIA PACIFIC PTE LTD**  
7030 Ang Mo Kio Ave 5  
#03-56 Northstar @ AMK  
Singapore 569 880













 (65) 6570 3233

 (65) 6570 6783

 [info@nenutec.com.sg](mailto:info@nenutec.com.sg)

## DAMPER ACTUATOR MODEL CHART

MODEL	 NACA	 NACM	 NECA	 NECM	 NASA	 NASM	 NAFA	 SAFA	 SASA	 NSVA
VOLTAGE 230VAC ~ 24VAC/DC	●	●	●	●	●	●	●	●	●	24 VAC
TORQUE (NM)	2 ; 5 ; 10 ; 20 ; 40	2 ; 5 ; 10 ; 20 ; 40	5 ; 10 ; 20	5 ; 10 ; 20	10 ; 20	10 ; 20	3 ; 5 ; 8 ; 20	3 ; 5 ; 8 ; 20	10 ; 15	5
CONTROL	2/3 pts	Modulating	2 pts	Modulating	2/3 pts	Modulating	2 pts SR	2 pts SR	3 pts	Modulating
SPECIAL TYPE										
ELECTRONIC RETURN			●	●						
FAST RUNNING					●	●			●	
SPRING RETURN							●			
FIRE & SMOKE SPRING RETURN								●		
SMOKE SAFETY								●	●	
NETWORKING										●

## TYPE DESIGNATION

TYPE	ACTUATOR	DESIGNATION	CONTROL	VOLTAGE	DOT	INPUT SIGNAL	HYPHENATED	TOUQE	AUXILIARY SWITCH
N	A	C	M	1	.	1	-	1 0	S1

<b>TYPE</b>	N = Standard Actuator
	S = Fire & Smoke
<b>ACTUATOR</b>	A = Standard Actuator
	E = Electronic Return
<b>DESIGNATION</b>	C = Standard Actuator
	S = Fast Running Actuator
	F = Spring Back Actuator
<b>CONTROL</b>	A = 2/3 Points
	M = Modulating
<b>VOLTAGE</b>	1 = 24 VAC/VDC
	2 = 230 VAC
	3 = 110/120 VAC
	4 = 48 VAC

<b>INPUT SIGNAL (NOT APPLICABLE FOR 2/3 POINTS)</b>	1 = 0(2)...10 VDC and 0(4)...20 mA	
	2 = 0(2)...10 VDC only	
	3 = 0...135 Ω only	
	4 = 4...20 mA only	
<b>TORQUE</b>	02 = 2 Nm	03 = 3 Nm
	05 = 5 Nm	08 = 8 Nm
	10 = 10 Nm	15 = 15 Nm
	20 = 20 Nm	40 = 40 Nm
<b>AUXILIARY SWITCH / FEEDBACK POTENTIOMETER</b>	None = No Auxiliary or Feedback Potentiometers	
	S1 = 1 x Auxiliary Switch	
	S = 2 x Auxiliary Switches	
	P1 = 1000Ω	P2 = 10000Ω
		P3 = 140Ω

# SASA SERIES

## FIRE & SMOKE DAMPER ACTUATOR

3 Point Non Spring Return Control  
10 Nm

### SASA...10S SERIES

SASA Non-Spring Return actuators are developed for use with fire and smoke damper. The actuator motorized the damper or other devices when power on.



### PRODUCT FEATURE

- Torque 10 Nm
- Damper size 2.0 m<sup>2</sup>
- Power supply AC/DC 24V and AC 230 V
- Shaft dimensions - Form fit 12 mm square
- Adapter supplied for Form Fit 8 or 10 mm square
- Selectable direction of rotation of reversing actuator
- Actuator with 1 m cable connection
- 2 Fixed auxiliary switches
- Manual Over-ride by crank handle when required
- Anti-rotation bracket provided for stability

### MODEL SELECTION TABLE

MODEL / TYPE	TORQUE	POWER SUPPLY	RUNNING TIME	AUXILIARY SWITCHES
SASA 1-10S	10 Nm	AC/DC 24 V $\pm$ 10%	< 30 sec	2 x SPDT (Fixed)
SASA 2-10S	10 Nm	AC 230 V $\pm$ 10%	< 30 sec	2 x SPDT (Fixed)

## DIMENSION (mm)

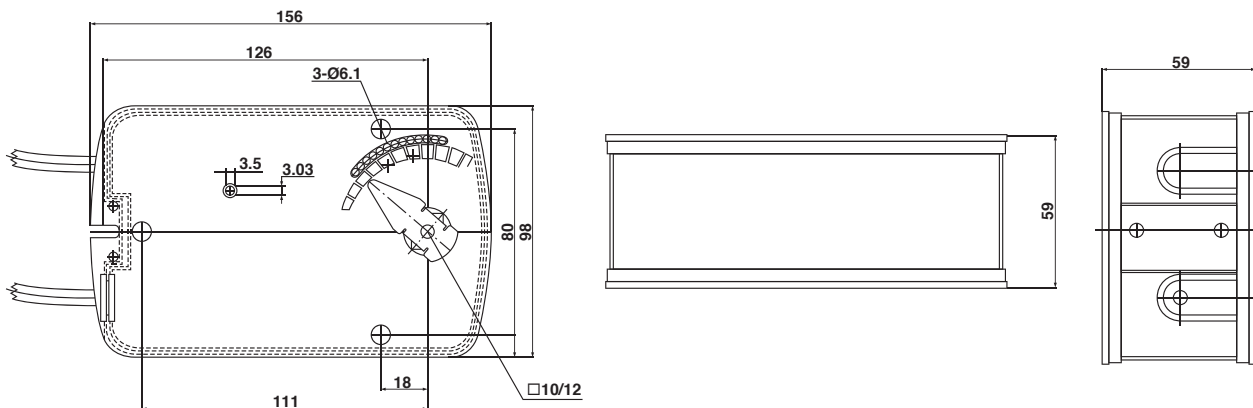

## TECHNICAL SPECIFICATION

MODEL NUMBER	SASA 1-10S	SASA 2-10S
TORQUE	10 Nm	10 Nm
DAMPER SIZE	2.0 m <sup>2</sup>	2.0 m <sup>2</sup>
SHAFT DIMENSION	From Fit 12 mm square	From Fit 12 mm square
POWER SUPPLY	AC/DC 24 V ± 10%	AC 230 V ± 10%
FREQUENCY	50...60 Hz	50...60 Hz
CONTROL SIGNAL	3 point control	3 point control
POWER CONSUMPTION		
● OPERATING	7.2 W	4.2 W
● END POSITION	2.5 W	2.5 W
FOR WIRE SIZING	10.0 VA	10.0 VA
ELECTRICAL CONNECTION	1 m Cable	1 m Cable
AUXILIARY SWITCHES RATING	3 (1.5) A, AC 250 V	3 (1.5) A, AC 250 V
PROTECTION CLASS	Class III ⚡	Class II ⚡
ANGLE OF ROTATION	90° (95° mechanical)	90° (95° mechanical)
WEIGHT	1.8 Kg	1.9 Kg
LIFE CYCLE	60,000 Rotation	60,000 Rotation
SOUND LEVEL	45 dB	45 dB
IP PROTECTION	IP54	IP54
OPERATING TEMPERATURE	-20°...50° as per IEC 721-3-3	-20°...50° as per IEC 721-3-3
NON-OPERATING TEMPERATURE	-30°...+60° C / IEC 721-3-2	-30°...+60° C / IEC 721-3-2
AMBIENT HUMIDITY	5%...95% rH non condensing / EN	5%...95% rH non condensing / EN
MAINTENANCE	Maintenance Free	Maintenance Free
MODE OF OPERATION	Type I / EN 60730-1	Type I / EN 60730-1
EMC	CE, UL 873 & ISO 9000 EN / EEC	CE, UL 873 & ISO 9000 EN / EEC

# SASA SERIES FIRE & SMOKE DAMPER ACTUATOR

3 Point Non Spring Return Control  
10 Nm

## WIRING DIAGRAM SASA...10S POWER SUPPLY AC/DC 24 V / AC 230V

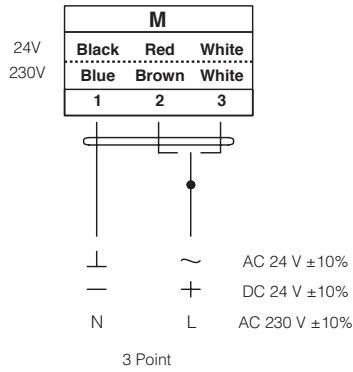

⚠ Connect via safety isolating transformer

## DIRECTION OF ROTATION SASA...10S

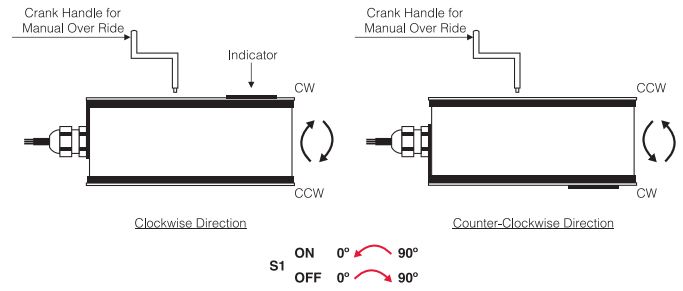

## WIRING DIAGRAM SASA...10S AUXILIARY SWITCHES

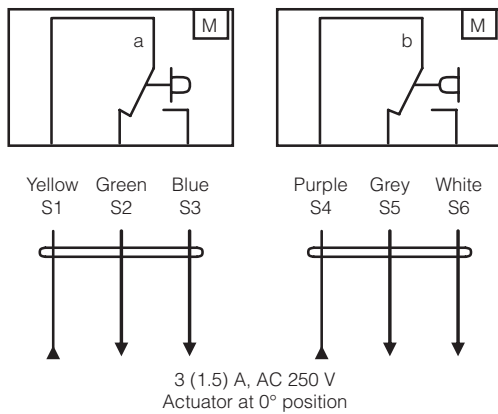

## AUXILIARY SWITCHES SASA...10S

Auxiliary are fixed at 5° for switch (a) and 85° for switch (b)  
Auxiliary switches are non adjustable.

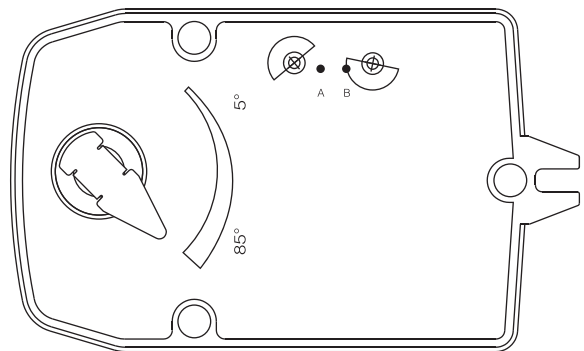

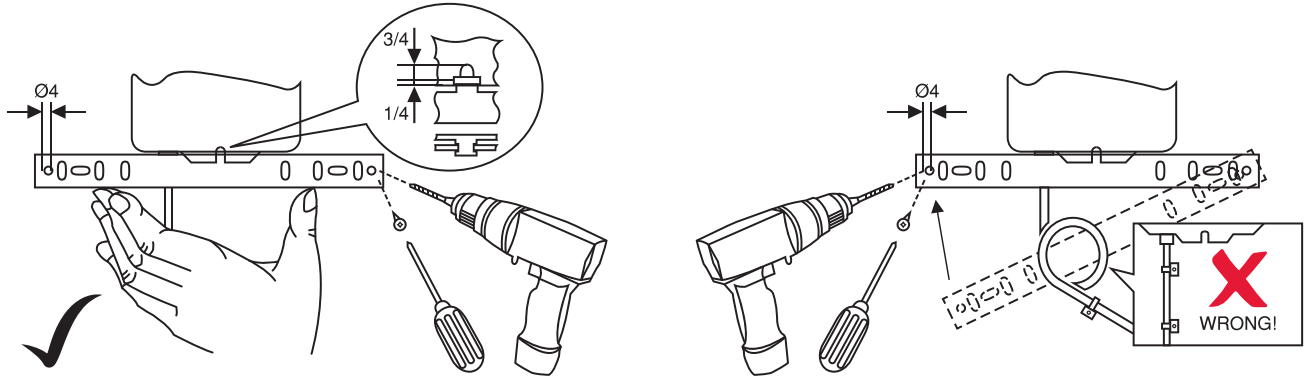

## INSTALLATION / MOUNTING INSTRUCTION



### IMPORTANT REMARK

For special requirement, consult your local NenuTec's representative.

  This actuator includes electrical and electronic components and may not be disposed as household garbage. Please consider the local valid legislation.

 AC / DC 24 V: Connect via safety isolating transformer.  
AC 230 V: To isolate from the main power supply, the system must incorporate a device which disconnects the phase conductor (with at least a 3mm contact gap.)

The performance specifications are nominal and conform to acceptable industry standards. NENU TEC shall not be liable for damages resulting from misapplication or misuse of its products.