

# NEBM SERIES

## BALL VALVE ELECTRONIC RETURN ACTUATOR

Modulating Control  
5 Nm

# NENUTEC<sup>®</sup>

INNOVATIVE MEMBER OF SWIS<sup>+</sup>TEC

**NENUTEC ASIA PACIFIC PTE LTD**  
7030 Ang Mo Kio Ave 5  
#03-56 Northstar @ AMK  
Singapore 569 880



 (65) 6570 3233

 (65) 6570 6783

 [info@nenutec.com.sg](mailto:info@nenutec.com.sg)

# NEBM SERIES BALL VALVE ELECTRONIC RETURN ACTUATOR

Modulating Control  
5 Nm



**High Neck  
Ball Valve Actuator**



**Low Neck  
Ball Valve Actuator**

## NEBM...05 SERIES

NEBM series electronic return valve actuators are especially designed and produced for applications in the HVAC systems. Our wide range of standard valve actuators has been developed to operate and position ball valves of different sizes.

## PRODUCT FEATURE

- Torque 5 Nm
- Valve size DN15(½") / DN20(¾") / DN25(1") / DN32(1¼")
- Power supply AC/DC 24 V
- Control Modulating DC 0 .....10v
- Shaft dimensions - □ 9.0 mm (fixed)
- Selectable direction of rotation of reversing actuator
- Actuator with 1 m cable connection
- Available in high neck and low neck

## MODEL SELECTION TABLE

MODEL / TYPE	TORQUE	POWER SUPPLY	RUNNING TIME	RETURN	AUXILIARY SWITCH
NEBM 1.2-05 LN	5 Nm	AC/DC 24 V ± 10%	50...55 sec	20 sec	-
NEBM 1.2-05 HN	5 Nm	AC/DC 24 V ± 10%	50...55 sec	20 sec	-

## DIMENSION (mm)

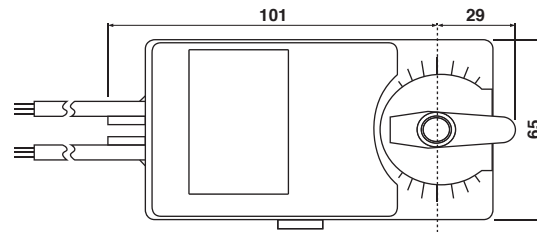
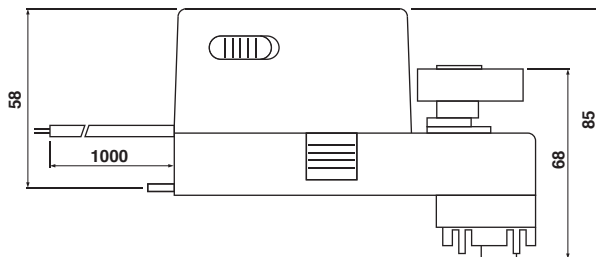

For Low Neck:

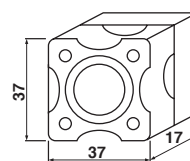

For High Neck:

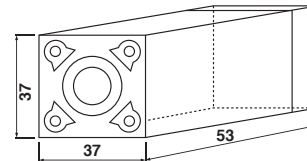

## TECHNICAL SPECIFICATION

<b>MODEL NUMBER</b>	<b>NEBM 1-05</b>
<b>TORQUE</b>	5 Nm
<b>VALVE SIZE</b>	DN15(½") / DN20(¾") / DN25(1") / DN32(1¼")
<b>SHAFT DIMENSIONS</b>	□ 9.0 mm (fixed)
<b>POWER SUPPLY</b>	AC/DC 24 V ± 10%
<b>FREQUENCY</b>	50...60 Hz
<b>CONTROL SIGNAL (INPUT)</b>	DC 0(2)...10V
<b>POSITION SIGNAL (OUTPUT)</b>	DC 0 .....10v
<b>POWER CONSUMPTION</b>	
● OPERATING	8.7 W
● END POSITION	1.2 W
<b>FOR WIRE SIZING</b>	14.0 VA
<b>ELECTRICAL CONNECTION</b>	1 m Cable
<b>AUXILIARY SWITCH RATING</b>	3 (1.5) A, AC 250 V
<b>PROTECTION CLASS</b>	Class III ⚡
<b>ANGLE OF ROTATION</b>	90° (95° mechanical)
<b>WEIGHT</b>	< 0.8 Kg
<b>LIFE CYCLE</b>	60,000 Rotation
<b>SOUND LEVEL</b>	40 dB
<b>IP PROTECTION</b>	IP54
<b>OPERATING TEMPERATURE</b>	-20°...50° as per IEC 721-3-3
<b>NON-OPERATING TEMPERATURE</b>	-30°...+60° C / IEC 721-3-2
<b>AMBIENT HUMIDITY</b>	5%...95% rH non condensing / EN
<b>MAINTENANCE</b>	Maintenance Free
<b>MODE OF OPERATION</b>	Type I / EN 60730-1
<b>EMC</b>	CE & ISO 9000 EN / EEC

# NEBM SERIES BALL VALVE ELECTRONIC RETURN ACTUATOR

Modulating Control  
5 Nm

## WIRING DIAGRAM NEBM...05 POWER SUPPLY AC/DC 24V

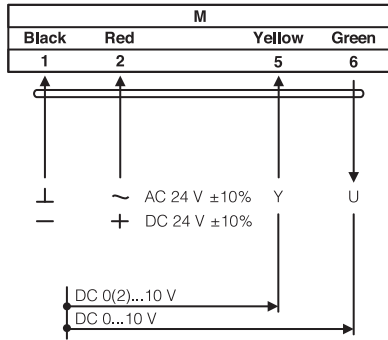

## DIRECTION OF ROTATION NEBM...05

Default factory setting: CCW.

Direction of rotation can be change by toggling between CW/CCW switch on the actuator's housing.

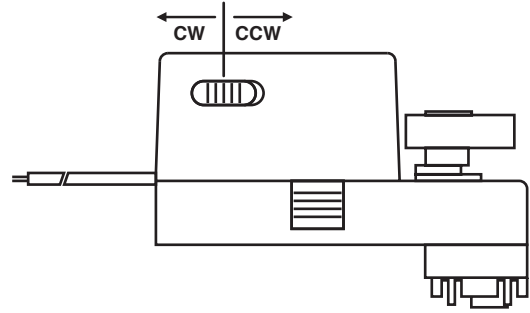

## WIRING DIAGRAM NEBM...05 PARALLEL CONNECTION

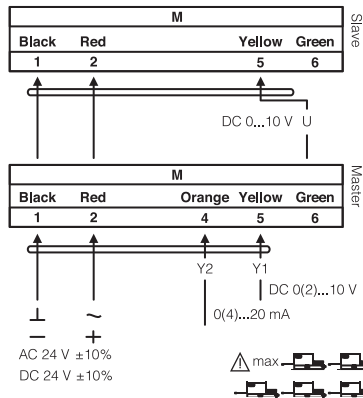

## REMARK

During parallel operation, the output signal (terminal 6, DC 0...10 V) of the master actuator must be connected to terminal 5 of the next slave actuator.

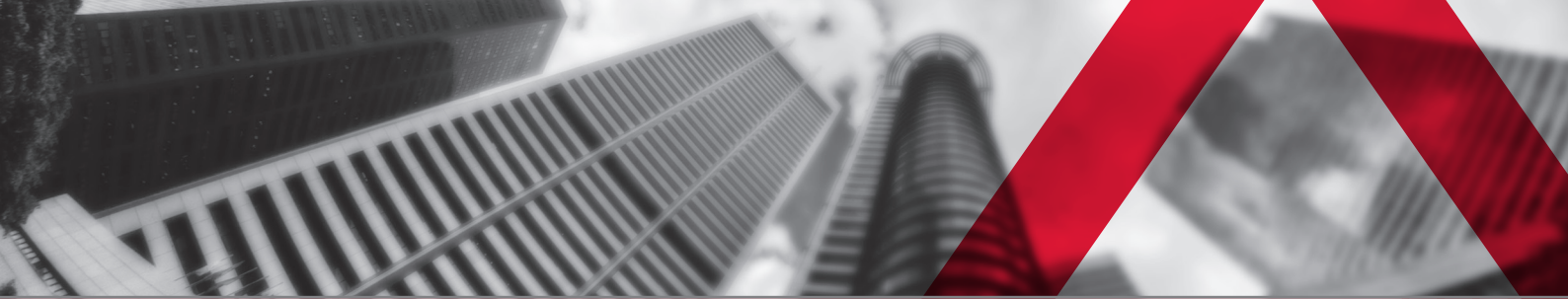

### MIXING CLOSED

### MIXING OPEN

### ACTUATOR POSITION

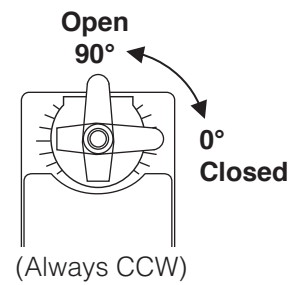
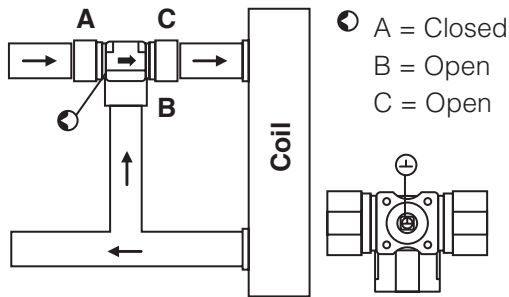
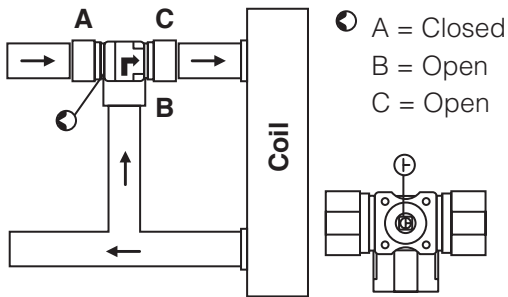

#### 2-way Closed 2-way Open

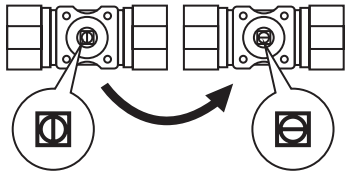

#### 3-way Closed 3-way Open

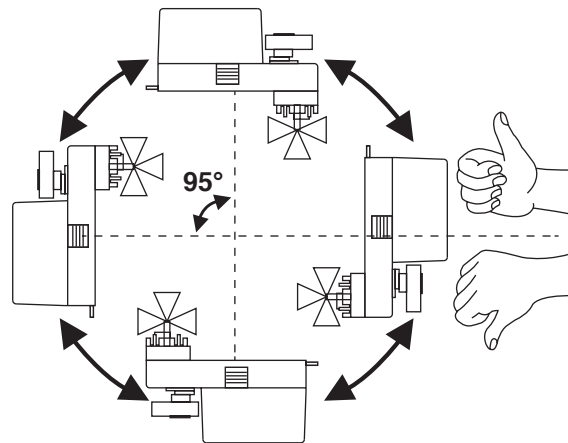
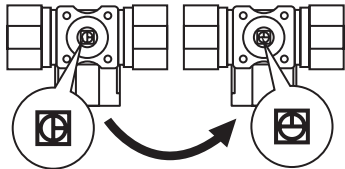

### IMPORTANT REMARK

For special requirement, consult your local Nenutec's representative.

This actuator includes electrical and electronic components and may not be disposed as household garbage. Please consider the local valid legislation.

AC / DC 24 V: Connect via safety isolating transformer.  
 AC 230 V: To isolate from the main power supply, the system must incorporate a device which disconnects the phase conductor (with at least a 3mm contact gap.)

The performance specifications are nominal and conform to acceptable industry standards. NENUTEC shall not be liable for damages resulting from misapplication or misuse of its products.