

SAFA SERIES FIRE & SMOKE DAMPER ACTUATOR

2 Point Spring Return Control
3 Nm

NENUTEC[®]

INNOVATIVE MEMBER OF SWIS⁺TEC

NENUTEC ASIA PACIFIC PTE LTD
7030 Ang Mo Kio Ave 5
#03-56 Northstar @ AMK
Singapore 569 880













 (65) 6570 3233

 (65) 6570 6783

 info@nenutec.com.sg

DAMPER ACTUATOR MODEL CHART

MODEL	 NACA	 NACM	 NECA	 NECM	 NASA	 NASM	 NAFA	 SAFA	 SASA	 NSVA
VOLTAGE 230VAC ~ 24VAC/DC	●	●	●	●	●	●	●	●	●	24 VAC
TORQUE (NM)	2 ; 5 ; 10 ; 20 ; 40	2 ; 5 ; 10 ; 20 ; 40	5 ; 10 ; 20	5 ; 10 ; 20	10 ; 20	10 ; 20	3 ; 5 ; 8 ; 20	3 ; 5 ; 8 ; 20	10 ; 15	5
CONTROL	2/3 pts	Modulating	2 pts	Modulating	2/3 pts	Modulating	2 pts SR	2 pts SR	3 pts	Modulating
SPECIAL TYPE										
ELECTRONIC RETURN			●	●						
FAST RUNNING					●	●			●	
SPRING RETURN							●			
FIRE & SMOKE SPRING RETURN								●		
SMOKE SAFETY								●	●	
NETWORKING										●

TYPE DESIGNATION

TYPE	ACTUATOR	DESIGNATION	CONTROL	VOLTAGE	DOT	INPUT SIGNAL	HYPHENATED	TOUQE	AUXILIARY SWITCH
N	A	C	M	1	.	1	-	1 0	S1

TYPE	N = Standard Actuator
	S = Fire & Smoke
ACTUATOR	A = Standard Actuator
	E = Electronic Return
DESIGNATION	C = Standard Actuator
	S = Fast Running Actuator
	F = Spring Back Actuator
CONTROL	A = 2/3 Points
	M = Modulating
VOLTAGE	1 = 24 VAC/VDC
	2 = 230 VAC
	3 = 110/120 VAC
	4 = 48 VAC

INPUT SIGNAL (NOT APPLICABLE FOR 2/3 POINTS)	1 = 0(2)...10 VDC and 0(4)...20 mA	
	2 = 0(2)...10 VDC only	
	3 = 0...135 Ω only	
	4 = 4...20 mA only	
TORQUE	02 = 2 Nm	03 = 3 Nm
	05 = 5 Nm	08 = 8 Nm
	10 = 10 Nm	15 = 15 Nm
	20 = 20 Nm	40 = 40 Nm
AUXILIARY SWITCH / FEEDBACK POTENTIOMETER	None = No Auxiliary or Feedback Potentiometers	
	S1 = 1 x Auxiliary Switch	
	S = 2 x Auxiliary Switches	
	P1 = 1000Ω	P2 = 10000Ω
		P3 = 140Ω

SAFA SERIES FIRE & SMOKE DAMPER ACTUATOR

2 Point Spring Return Control
3 Nm

SAFA...03S (T) SERIES

SAFA series Spring Return damper actuators are designed specifically for fire and smoke application. During normal operation, the actuator motorized the damper. In the event of fire emergency, the actuator springs back to its original position when there is power outage or trip by thermal sensor.



PRODUCT FEATURE

- Torque 3 Nm
- Damper size 0.6 m²
- Power supply AC/DC 24V and AC 230 V
- Shaft dimensions - Form fit 12 mm square
- Adapter supplied for Form fit 8 or 10 mm square
- Selectable direction of rotation
- Actuator with 1 m cable connection
- 2 Fixed auxiliary switches (SPDT)
- Manual Over-ride by crank handle when required
- Thermal sensor option available
- Anti rotation bracelet provided

MODEL SELECTION TABLE

MODEL / TYPE	TORQUE	POWER SUPPLY	RUNNING TIME	AUXILIARY SWITCHES	THERMAL SENSOR
SAFA 1-03S	3 Nm	AC/DC 24 V ± 10%	25...35 sec (Spring Back <12 sec)	2 x SPDT (Fixed)	-
SAFA 1-03ST	3 Nm	AC/DC 24 V ± 10%	25...35 sec (Spring Back <12 sec)	2 x SPDT (Fixed)	Yes
SAFA 2-03S	3 Nm	AC 230 V ± 10%	25...35 sec (Spring Back <12 sec)	2 x SPDT (Fixed)	-
SAFA 2-03ST	3 Nm	AC 230 V ± 10%	25...35 sec (Spring Back <12 sec)	2 x SPDT (Fixed)	Yes

DIMENSION (mm)

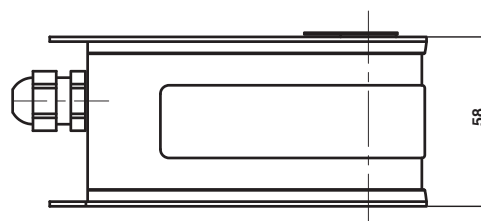
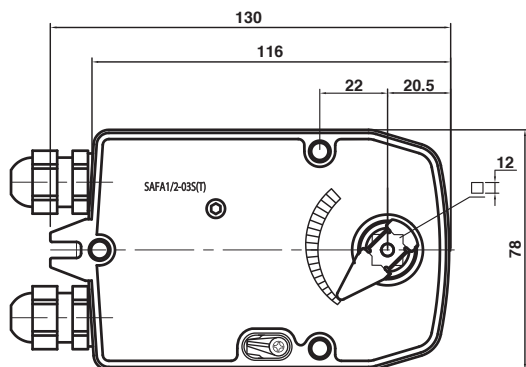

TECHNICAL SPECIFICATION

MODEL NUMBER	SAFA 1-03S (T)	SAFA 2-03S (T)
TORQUE	3 Nm	3 Nm
DAMPER SIZE	0.6 m ²	0.6 m ²
SHAFT DIMENSION	Form fit 12 mm square	Form fit 12 mm square
POWER SUPPLY	AC/DC 24 V ± 10%	AC 230 V ± 10%
FREQUENCY	50...60 Hz	50...60 Hz
CONTROL SIGNAL	2 point control	2 point control
POWER CONSUMPTION		
● OPERATING	7.0 W	7.0 W
● END POSITION	2.5 W	2.5 W
FOR WIRE SIZING	10.0 VA	10.0 VA
ELECTRICAL CONNECTION	1 m Cable	1 m Cable
AUXILIARY SWITCHES RATING	3 (1.5) A, AC 250 V	3 (1.5) A, AC 250 V
PROTECTION CLASS	Class III ⚡	Class II ⚡
ANGLE OF ROTATION	90° (95° mechanical)	90° (95° mechanical)
THERMAL TEMPERATURE TRIP	> 72°C	> 72°C
WEIGHT	1.8 Kg	1.9 Kg
LIFE CYCLE	60,000 Rotation	60,000 Rotation
SOUND LEVEL	40 dB	40 dB
IP PROTECTION	IP54	IP54
OPERATING TEMPERATURE	-20°...50° as per IEC 721-3-3	-20°...50° as per IEC 721-3-3
NON-OPERATING TEMPERATURE	-30°...+60° C / IEC 721-3-2	-30°...+60° C / IEC 721-3-2
AMBIENT HUMIDITY	5%...95% rH non condensing / EN	5%...95% rH non condensing / EN
MAINTENANCE	Maintenance Free	Maintenance Free
MODE OF OPERATION	Type I / EN 60730-1	Type I / EN 60730-1
EMC	CE, UL 873 & ISO 9000 EN / EEC	CE, UL 873 & ISO 9000 EN / EEC

SAFA SERIES FIRE & SMOKE DAMPER ACTUATOR

2 Point Spring Return Control

3 Nm

WIRING DIAGRAM SAFA...03S (T) POWER SUPPLY AC/DC 24 V / AC 230V

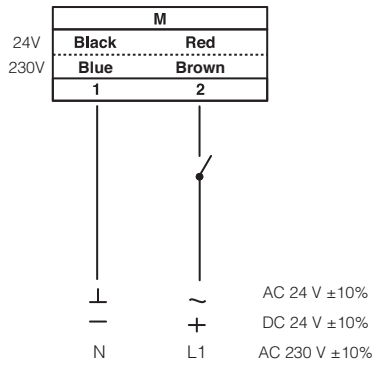

DIRECTION OF ROTATION SAFA...03S (T)

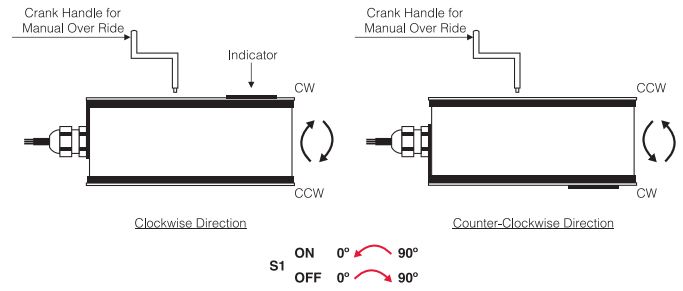

WIRING DIAGRAM SAFA...03S (T) AUXILIARY SWITCHES

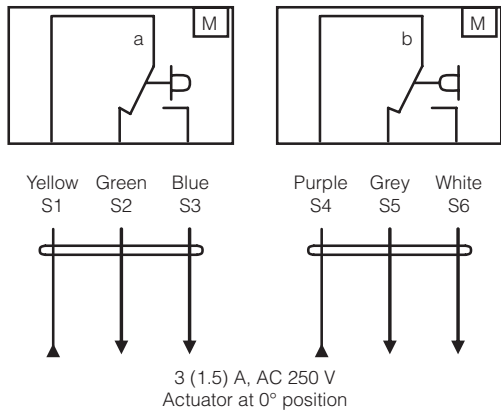

AUXILIARY SWITCHES SAFA...03S (T)

Auxiliary are fixed at 5° for switch (a) and 85° for switch (b)
Auxiliary switches are non adjustable.

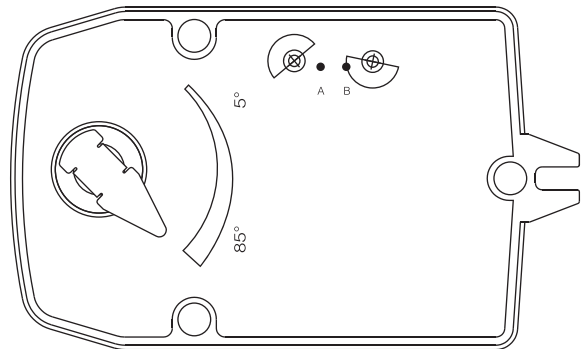

THERMAL SENSOR NTS72

Thermal Sensor NTS 72 consist of both Ambient (TS1) and Duct sensor (TS2).

- TS1 will trip open when the ambient temperature rise above 72°.
- TS2 will trip open when the duct temperature rise above 72°.

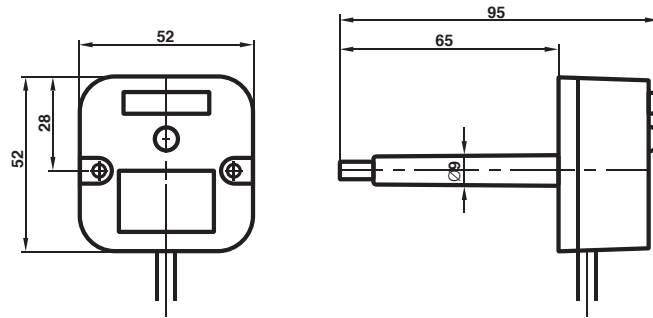

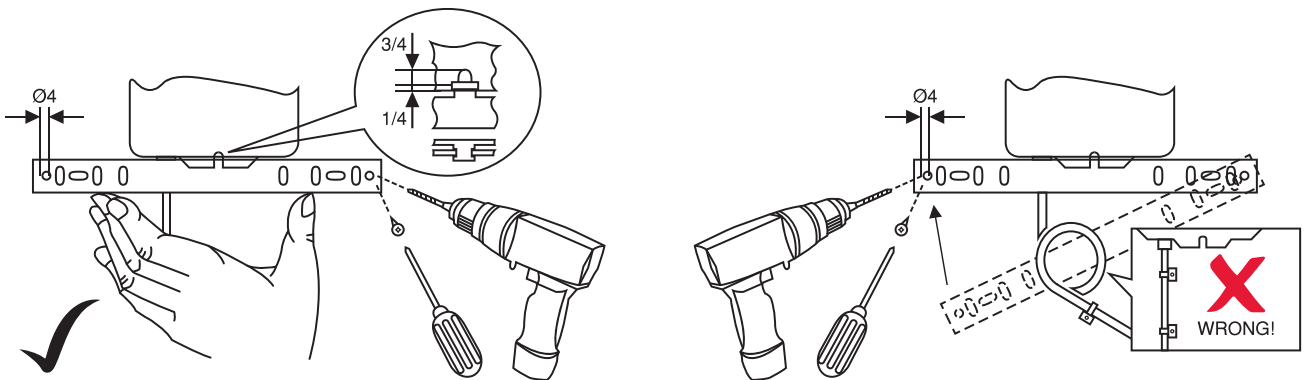

INSTALLATION / MOUNTING INSTRUCTION



IMPORTANT REMARK

For special requirement, consult your local Nenutec's representative.

  This actuator includes electrical and electronic components and may not be disposed as household garbage. Please consider the local valid legislation.

 AC / DC 24 V: Connect via safety isolating transformer.
AC 230 V: To isolate from the main power supply, the system must incorporate a device which disconnects the phase conductor (with at least a 3mm contact gap.)

The performance specifications are nominal and conform to acceptable industry standards. Nenutec shall not be liable for damages resulting from misapplication or misuse of its products.