

# NECA...10 (S1) SERIES

## ELECTRONIC RETURN DAMPER ACTUATOR 2 POINT CONTROL



### NECA...10 (S1) SERIES

NECA SERIES damper actuators with Electronic Return® (ER) function are designed and produced for extended functionalities in the HVAC Systems: air handling equipment, fan coils and laboratory applications. Electronic Return® (ER) is able to manage short voltage interruptions for max. 10 seconds.

### PRODUCT FEATURE

- Torque 10 Nm
- Damper size 2.0 m<sup>2</sup>
- Power supply AC/DC 24V or AC 230V
- Shaft dimensions - Ø 10...16 mm / □ 7...12 mm
- Minimum shaft length 45 mm
- Adjustable angle of rotation
- Selectable direction of rotation of reversing actuator
- Optional 1 adjustable SPDT auxiliary switch
- Manual over-ride push button when required

### MODEL SELECTION TABLE

MODEL /TYPE	TORQUE	POWER SUPPLY	RUNNING	RETURN	AUXILIARY SWITCH
NECA 1-10	10 Nm	AC/DC 24V ± 10%	60...90 sec	40 sec	-
NECA 1-10S1	10 Nm	AC/DC 24V ± 10%	60...90 sec	40 sec	1 x SPDT (Adjustable)
NECA 2-10	10 Nm	AC 230V ± 10%	60...90 sec	40 sec	-
NECA 2-10S1	10 Nm	AC 230V ± 10%	60...90 sec	40 sec	1 x SPDT (Adjustable)

### DIMENSION (mm)

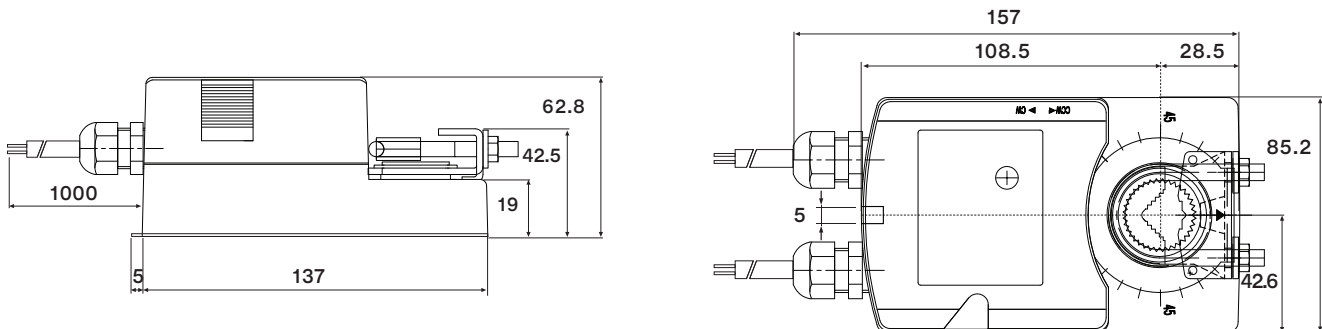

## TECHNICAL SPECIFICATION

<b>MODEL NUMBER</b>	NECA 1-10 (S1)	NECA 2-10 (S1)
<b>TORQUE</b>	10 Nm	10 Nm
<b>DAMPER SIZE</b>	2.0 m <sup>2</sup>	2.0 m <sup>2</sup>
<b>SHAFT DIMENSION</b>	Ø 10...16 mm / □7...12 mm*	Ø 10...16 mm / □ 7...12 mm*
<b>POWER SUPPLY</b>	AC/DC 24 V ± 10%	AC 230 V ± 10%
<b>FREQUENCY</b>	50...60 Hz	50...60 Hz
<b>CONTROL SIGNAL</b>	2 point control	2 point control
<b>POWER CONSUMPTION</b>		
• <b>OPERATING</b>	7.2 W	7.2 W
• <b>END POSITION</b>	1.2 W	1.2 W
<b>FOR WIRE SIZING</b>	10.0 VA	10.0 VA
<b>ELECTRICAL CONNECTION</b>	1 m Cable	1 m Cable
<b>AUXILIARY SWITCH RATING</b>	2 (1.5) A / AC 250 V	2 (1.5) A / AC 250 V
<b>PROTECTION CLASS</b>	Class III ⚡	Class II ⚡
<b>ANGLE OF ROTATION</b>	90° (95° mechanical)	90° (95° mechanical)
<b>WEIGHT</b>	1.1 Kg	1.1 Kg
<b>LIFE CYCLE</b>	60,000 Rotation	60,000 Rotation
<b>SOUND LEVEL</b>	< 45 dB (A)	< 45 dB (A)
<b>IP PROTECTION</b>	IP54	IP54
<b>OPERATING TEMPERATURE</b>	-30°...50° as per IEC 721-3-3	-30°...50° as per IEC 721-3-3
<b>NON-OPERATING TEMPERATURE</b>	-30°...+60° C / IEC 721-3-2	-30°...+60° C / IEC 721-3-2
<b>AMBIENT HUMIDITY</b>	5%...95% rH non condensing / EN	5%...95% rH non condensing / EN
<b>MAINTENANCE</b>	Maintenance Free	Maintenance Free
<b>MODE OF OPERATION</b>	Type I / EN 60730-1	Type I / EN 60730-1
<b>EMC</b>	CE & ISO 9000 EN / EEC	CE & ISO 9000 EN / EEC

\*Note that shaft dimension has a tolerance offset of ± 0.2mm.

# NECA...10 (S1) SERIES

## ELECTRONIC RETURN DAMPER ACTUATOR 2 POINT CONTROL

### WIRING DIAGRAM NECA...10 (S1) POWER SUPPLY AC/DC 24V OR AC 230V

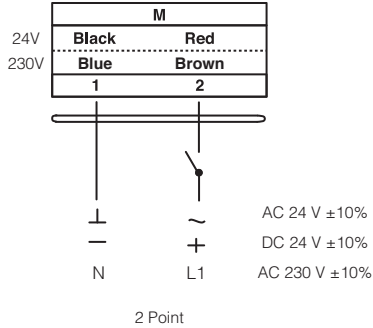

⚠ Connect via safety isolating transformer

### DIRECTION OF ROTATION NECA...10 (S1)

Default factory setting: CW.

Direction of rotation can be changed by toggling between CW/CCW switch on the actuator's housing.

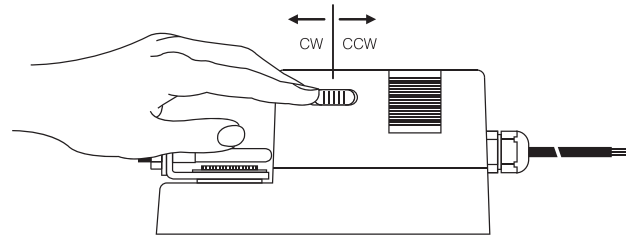

### WIRING DIAGRAM NECA...10 (S1) AUXILIARY SWITCH

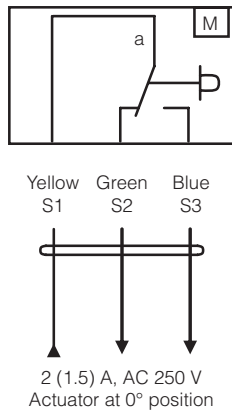

### AUXILIARY SWITCH NECA...10 (S1)

Auxiliary switch (a) factory-set at 5°.

Auxiliary switch (a) can be optimally adjusted between 0°...90°.

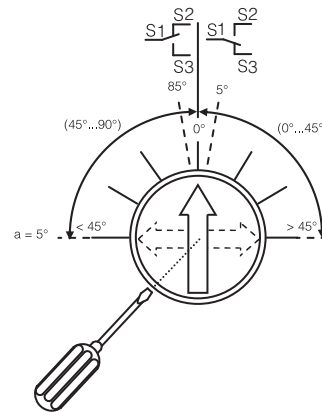

### WIRING DIAGRAM NECA...10 (S1) PARALLEL CONNECTION

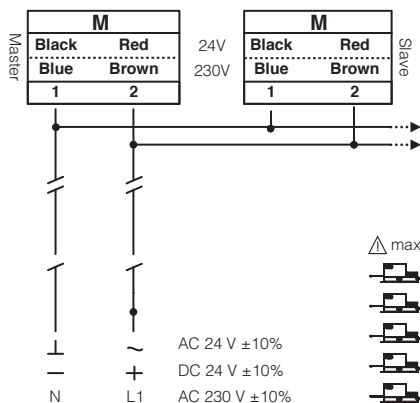

### REMARK

Parallel connection of NECA...10 (S1) actuators are limited to 5. Power consumption must be observed.

## RELEASING THE ADAPTER NECA...10 (S1)

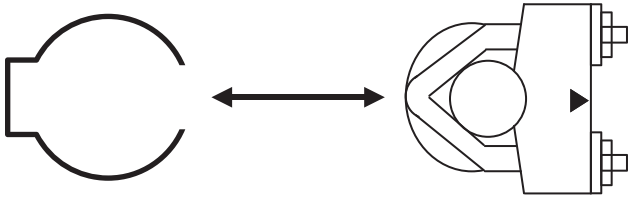

## LIMITING ANGLE OF ROTATION NECA...10 (S1)

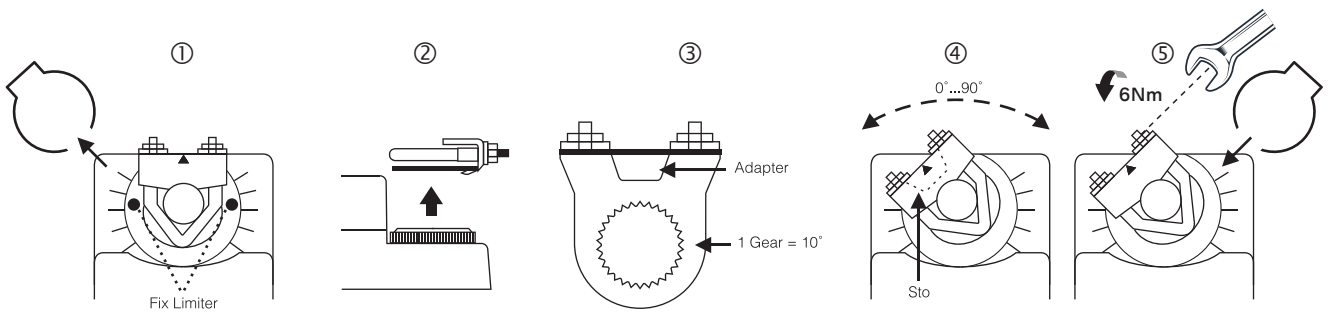

## INSTALLATION / MOUNTING INSTRUCTION

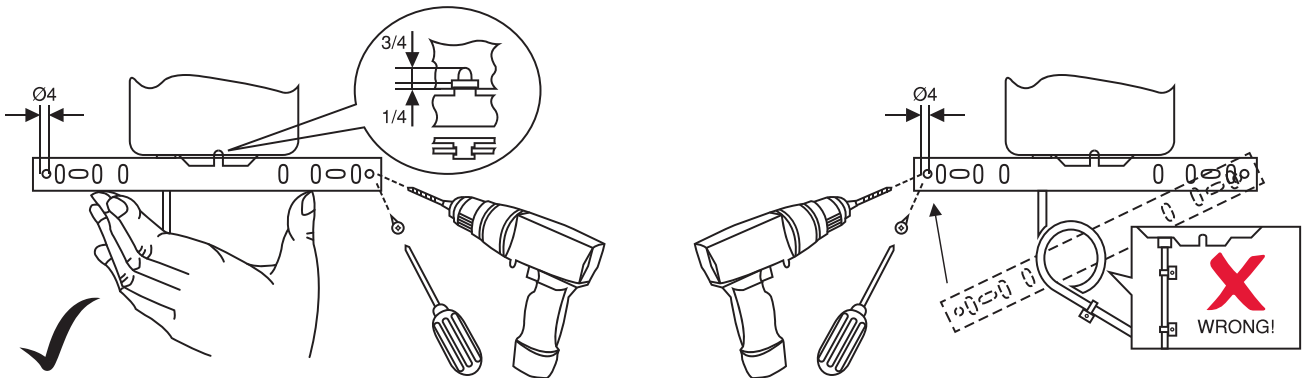

## IMPORTANT REMARK

For special requirement, consult your local Nenutec's representative.



This actuator includes electrical and electronic components and may not be disposed as household garbage. Please consider the local valid legislation.



AC / DC 24 V: Connect via safety isolating transformer.  
AC 230 V: To isolate from the main power supply, the system must incorporate a device which disconnects the phase conductor (with at least a 3mm contact gap.)

The performance specifications are nominal and conform to acceptable industry standards. NENUTEC shall not be liable for damages resulting from misapplication or misuse of its products.